



BATTEN LIGHTS

Cabinet lighting luminaires are suitable for illuminating the work area. They can be used in kitchens, workshops or even indoors thanks to their clean appearance.

BATTEN LIGHTS



CABINET LIGHT + SENSOR
PAGE - 362.



CABINET LIGHT + SENSOR
PAGE - 362.



**RECHARGEABLE CABINET LAMP PIR
SENSOR**
PAGE - 363.



**RECHARGEABLE CABINET LAMP PIR
SENSOR**
PAGE - 363.



CABINET LIGHT + SENSOR
PAGE - 363.



BATTEN LIGHTS
PAGE - 364.



CABINET LIGHT + SENSOR
PAGE - 364.



BATTEN LIGHTS
PAGE - 365.

LED STRIP CABINET LIGHT + SENSOR

A F 9W | 600mm | 220-240V | 120° | 25 000h | 30/c

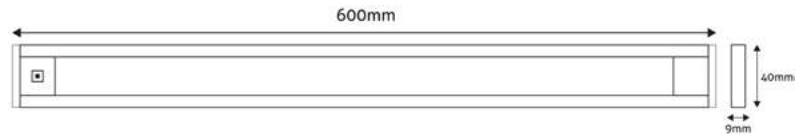

ABLSCAB-60NW-BL1

900lm

5999562288788

LED STRIP CABINET LIGHT + SENSOR

A F 5W | 500mm | 220-240V | 120° | 25 000h | 20/c

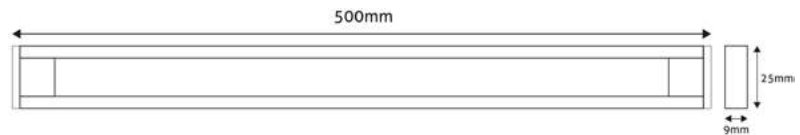

ABLSCAB-50NW-BL2

500lm

5999562288443

LED STRIP CABINET LIGHT + SENSOR

A F 9W | 600mm | 220-240V | 120° | 25 000h | 20/c

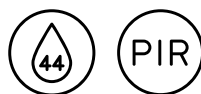
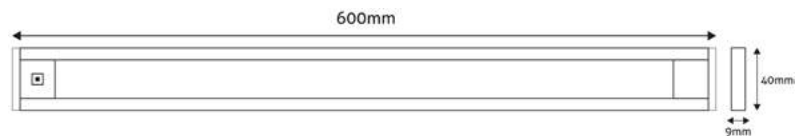

ABLSCAB-60NW-BL2

900lm

5999562288429



LED CABINET LIGHT WITH BUILT-IN BATTERY PIR

2.5W | 310mm | 360° | 25 000h | 60/c

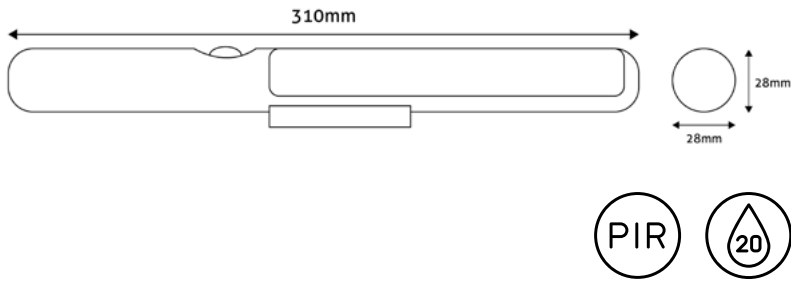

ABLSCAB-30WWR	200lm	5999097943008
---------------	-------	---------------

LED CABINET LIGHT WITH BUILT-IN BATTERY PIR

2.5W | 300mm | 360° | 25 000h | 40/c

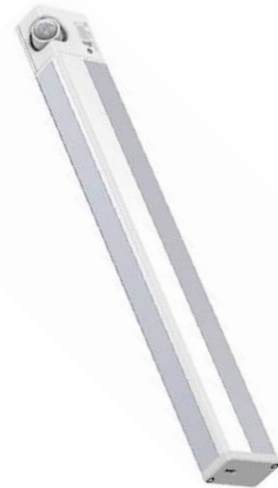
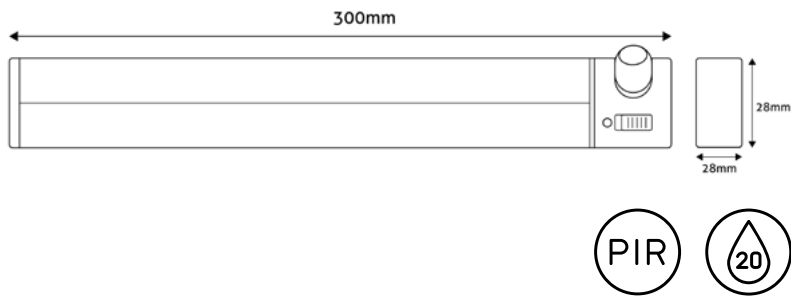

ABLSCAB-30WWS	200lm	5999097943022
---------------	-------	---------------

LED CABINET LIGHT WITH HANDWAVE SENSOR

9W | 600mm | 220-240V | 360° | 25 000h | 40/c

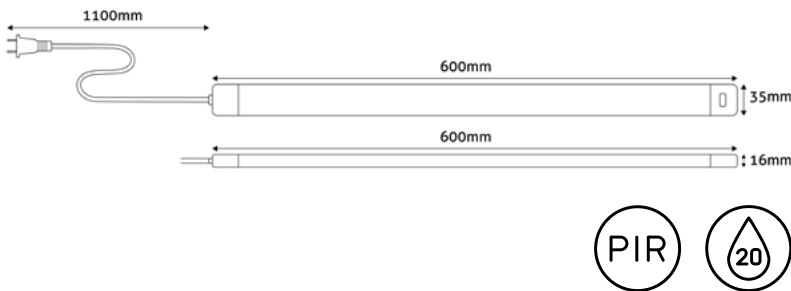

ABLSCAB-60WW-HS	500lm	5999097952444
ABLSCAB-60NW-HS	500lm	5999097943046



LED BATTEN LIGHT

A **F** 16W | 600mm | 220-240V | 120° | 20 000h | 50/c

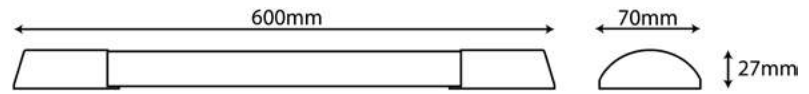

ALBLWW-16W	1 472lm	5999097919881
ALBLNW-16W	1 600lm	5999097919805
ALBLCW-16W	1 600lm	5999097919966



LED BATTEN LIGHT

A **F** 30W | 1 200mm | 220-240V | 120° | 20 000h | 40/c

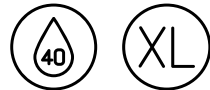
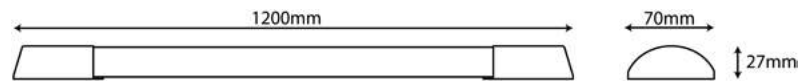

ALBLWW-30W	2 760lm	5999097919928
ALBLNW-30W	3 000lm	5999097919843
ALBLCW-30W	3 000lm	5999097920009



LED CABINET LIGHT EXCL.

0.7W | 260mm | 120° | 30/c

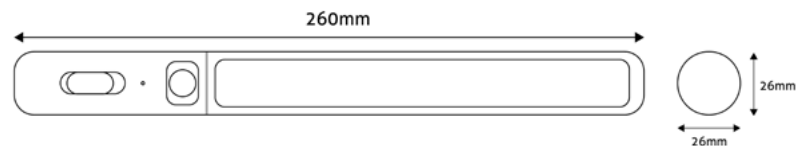

ABLSBCAB3AA-26WWR	87lm	5999097949864
-------------------	------	---------------



BATTEN LIGHTS

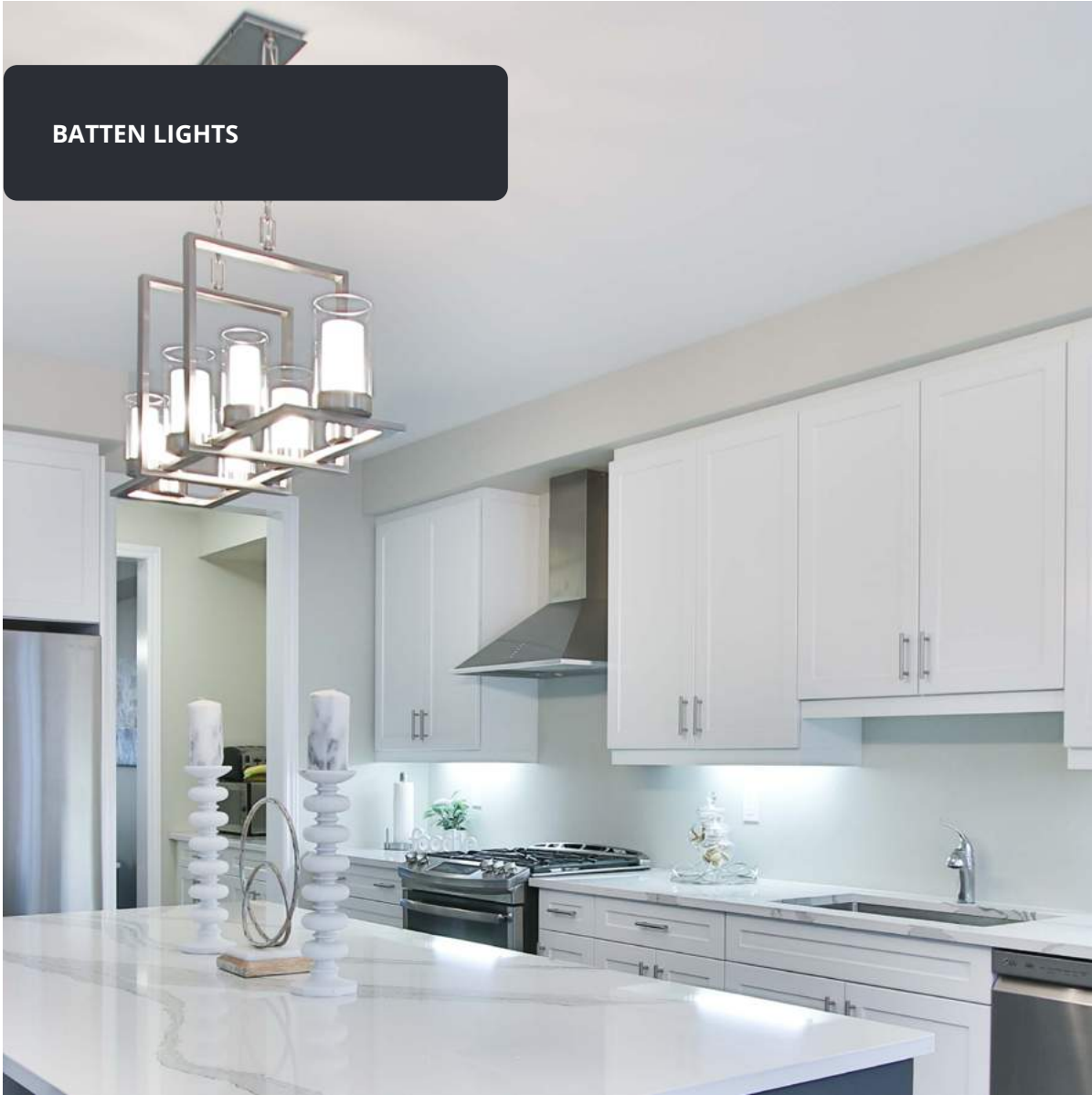

LED MIRROR LIGHT

10W | 220-240V | 120° | 50 000h | 12/c 

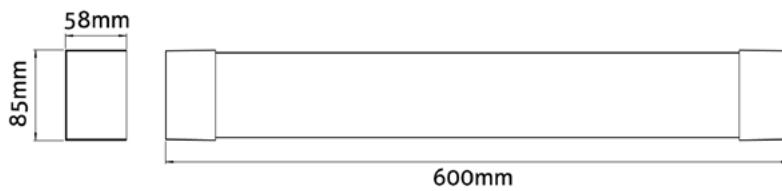

ATML-10W-CCT

1 100lm

5999097958767



LED TUBES

LED fluorescent tubes offer solution to replace conventional fluorescent tubes. Their brightness surpasses even of the neon tubes, their consumption is measurably lower. Integrated LED fluorescent tubes are flicker-free and they illuminate at their full brightness once switched on.

LED TUBES



INTEGRATED LED
PAGE - 368.



CABLE
PAGE - 369.



LED GLASS TUBE
PAGE - 370.



LED LINEAR
PAGE - 375.

INTEGRATED LED



LED T5 INTEGRATED TUBE WITH AC PLUG

6W | 600lm | 300mm | 120° | 220-240V | 25 000h | 25/c



AB300T5-6W-WW-CB	5999097943305
AB300T5-6W-NW-CB	5999097943282



LED T5 INTEGRATED TUBE WITH AC PLUG

9W | 850lm | 600mm | 120° | 220-240V | 25 000h | 25/c



AB600T5-9W-WW-CB	5999097934648
AB600T5-9W-NW-CB	5999097934624



LED T5 INTEGRATED TUBE WITH AC PLUG

15W | 1 500lm | 900mm | 120° | 220-240V | 25 000h | 25/c



AB900T5-15W-WW-CB	5999097934501
AB900T5-15W-NW-CB	5999097934488



LED T5 INTEGRATED TUBE WITH AC PLUG

19W | 2 000lm | 1 200mm | 120° | 220-240V | 25 000h | 25/c



AB1200T5-19W-WW-CB	5999097934426
AB1200T5-19W-NW-CB	5999097934600



CABLE

LED T5 INTEGRATED TUBE CONNECTOR CABLE

220-240V | 150mm



ABT5-CON

5999097909967

LED T5 INTEGRATED TUBE AC PLUG

220-240V | 6A | 1m |



ABT5-ACPLUG

5999562280089

**ECO LED TUBE
100LM/W**

LED GLASS TUBE G13 100LM/W

9W | 900lm | 600mm | 240° | 175-265V | 25 000h | 25/c

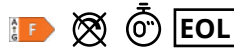

100lm/W

AE600T8-9W-NW	5999097945842
AE600T8-9W-CW	5999097947884

LED GLASS TUBE G13 100LM/W BULK

9W | 900lm | 600mm | 240° | 175-265V | 25 000h | 25/c



100lm/W

AEI600T8-9W-NW	5999097947983
AEI600T8-9W-CW	5999097948003

LED GLASS TUBE G13 100LM/W

18W | 1 800lm | 1 200mm | 240° | 175-265V | 25 000h | 25/c



100lm/W

AE1200T8-18W-NW	5999097945866
AE1200T8-18W-CW	5999097947921

LED GLASS TUBE G13 100LM/W BULK

18W | 1 800lm | 1 200mm | 240° | 175-265V | 25 000h | 25/c



100lm/W

AEI1200T8-18W-NW	5999097947945
AEI1200T8-18W-CW	5999097948041

LED GLASS TUBE G13 PAPERTUBE 120LM/W

18W | 2 160lm | 1 200mm | 240° | 180-265V | 25 000h | 25/c



120lm/W

AB1200T8-18W-NW-GL-IL-1	5999097950341
-------------------------	---------------

**LED GLASS TUBE G13 100LM/W**

24W | 2 400lm | 1 500mm | 240° | 175-265V | 25 000h | 25/c

**100lm/W**

AE1500T8-24W-NW 5999097945880

AE1500T8-24W-CW 5999097947907

LED GLASS TUBE G13 100LM/W BULK

24W | 2 400lm | 1 500mm | 240° | 175-265V | 25 000h | 25/c

**100lm/W**

AEI1500T8-24W-NW 5999097947969

AEI1500T8-24W-CW 5999097948027

**PROFESSIONAL LED TUBE
120LM/W****LED GLASS TUBE G13 120LM/W BULK**

9W | 1 080lm | 600mm | 240° | 175-265V | 25 000h | 25/c

**120lm/W**

AEI600T8-9W-NW-IL 5999097948225

LED GLASS TUBE G13 120LM/W

9W | 1 080lm | 600mm | 240° | 180-265V | 25 000h | 25/c

**120lm/W**

AB600T8-9W-NW-GL-IL 5999097925448

AB600T8-9W-CW-GL-IL 5999097925462

LED GLASS TUBE G13 PAPERTUBE 120LM/W

9W | 1 080lm | 600mm | 240° | 180-265V | 25 000h | 25/c

**120lm/W**

AB600T8-9W-NW-GL-IL-1 5999097925721

LED GLASS TUBE G13 120LM/W

9W | 1 080lm | 600mm | 240° | 175-265V | 25 000h | 25/c

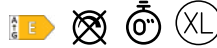

120lm/W

AE600T8-9W-WW-IL	5999097964843
AE600T8-9W-CW-IL	5999097948126
AE600T8-9W-NW-IL	5999097948102

LED GLASS TUBE G13 120LM/W BULK

18W | 2 160lm | 1 200mm | 240° | 175-265V | 25 000h | 25/c

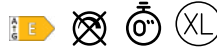

120lm/W

AE1200T8-18W-NW-IL	5999097948188
--------------------	---------------

LED GLASS TUBE G13 120LM/W

18W | 2 160lm | 1 200mm | 240° | 180-265V | 25 000h | 25/c

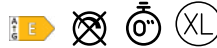

120lm/W

AB1200T8-18W-NW-GL-IL	5999097925509
-----------------------	---------------

LED GLASS TUBE G13 PAPERTUBE 120LM/W

22W | 2 640lm | 1 500mm | 240° | 180-265V | 25 000h | 25/c

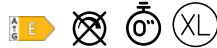

120lm/W

AB1500T8-22W-NW-GL-IL-1	5999097945163
-------------------------	---------------

AVIDE LED GLASS TUBE G13 120LM/W

18W | 2 160lm | 1 200mm | 240° | 175-265V | 25 000h | 25/c



120lm/W

AE1200T8-18W-WW-IL	5999097956282
AE1200T8-18W-NW-IL	5999097948065
AE1200T8-18W-CW-IL	5999097948164

LED GLASS TUBE G13 120LM/W

24W | 2 880lm | 1 500mm | 240° | 175-265V | 25 000h | 25/c

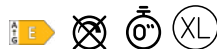

120lm/W

AE1500T8-24W-NW-IL	5999097948089
AE1500T8-24W-CW-IL	5999097948140



LED GLASS TUBE G13 120LM/W

22W | 2 640lm | 1 500mm | 240° | 180-265V | 25 000h | 25/c



120lm/W



AB1500T8-22W-NW-GL-IL

5999097945125

AB1500T8-22W-CW-GL-IL

5999097943268

LED GLASS TUBE G13 120LM/W BULK

24W | 2 880lm | 1 500mm | 240° | 175-265V | 25 000h | 25/c



120lm/W



AEI1500T8-24W-NW-IL

5999097948201

**INDUSTRIAL LED TUBE
150LM/W**

LED GLASS TUBE G13 HIGH LUMEN 150LM/W

9W | 1 350lm | 600mm | 240° | 180-265V | 25 000h | 25/c



150lm/W



AB600T8-9W-NW-GL-HL

5999097923581

LED GLASS TUBE G13 HIGH LUMEN 150LM/W

18W | 2 700lm | 1 200mm | 240° | 180-265V | 25 000h | 25/c



150lm/W



AB1200T8-18W-NW-GL-HL

5999097923642

LED GLASS TUBE G13 150LM/W

22W | 3 300lm | 1 500mm | 240° | 180-265V | 48 000h | 25/c



150lm/W



AB1500T8-22W-NW-GL-HL

5999097945149

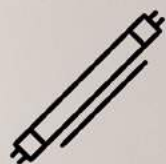

**GLASS TUBE
G13**



SMD
LED

CRI > 80





LED LINEAR

LED LINEAR 300MM S14D

5W | 450lm | 300mm | 120° | 220-240V | 25 000h | 50/c



ABS14DNW-5W

5999562284650

LED LINEAR 300MM S14S

5W | 400lm | 300mm | 120° | 220-240V | 25 000h | 50/c



ABS14SNW-5W

5999562284636

LED LINEAR 500MM S14D

8W | 630lm | 500mm | 120° | 220-240V | 25 000h | 50/c



ABS14DWW-8W

5999097920443

ABS14DNW-8W

5999562289266

LED LINEAR 500MM S14S

8W | 700lm | 500mm | 120° | 220-240V | 25 000h | 50/c



ABS14SNW-8W

5999562289280

LED LINEAR 500MM S14S

8W | 630lm | 500mm | 120° | 220-240V | 25 000h | 50/c



ABS14SWW-8W

5999097920467



TRI-PROOF FIXTURES

Due to their IP65 protection, these luminaires are fully protected from dust and vapour, thus, they have a high level of protection against entry of vapour, dust and other solids. They are recommended for the illumination of industrial halls, storage rooms, corridors, workshop rooms or cellars.

TRI-PROOF FIXTURES



TRI-PROOF FIXTURES
PAGE - 378.



**LED INTEGRATED TRI-PROOF
FIXTURE**
PAGE - 380.

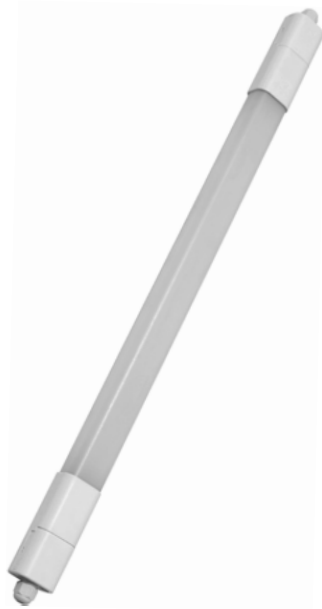

LED NANO LIGHT LINKABLE
PAGE - 356.



TRI-PROOF FIXTURE FOR 1 LED TUBE 0.6M

1x18W | 600mm | AC85-265V | 90x600x656mm | 12/c

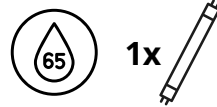
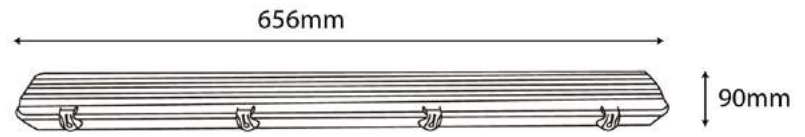

ATPF-1X18W

5999097916361



TRI-PROOF FIXTURE FOR 1 LED TUBE 1.2M

1x36W | 1200mm | AC85-265V | 80x90x1260mm | 12/c

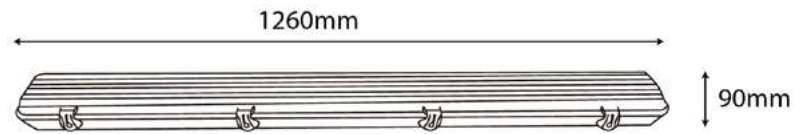

ATPF-1X36W

5999097916408



TRI-PROOF FIXTURE FOR 1 LED TUBE 1.5M

1x58W | 1500mm | AC85-265V | 80x90x1560mm | 8/c

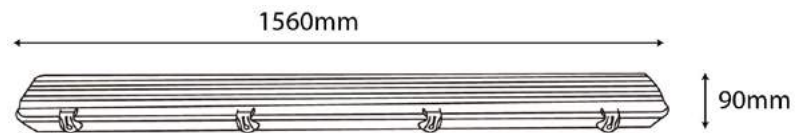

ATPF-1X58W

5999097916446



TRI-PROOF FIXTURE FOR 2 LED TUBE 0.6M

2x18W | 600mm | AC85-265V | 115x90x656mm | 8/c

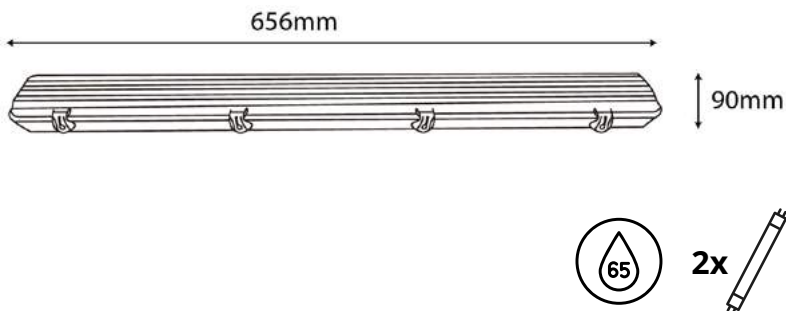

ATPF-2X18W

5999097916385

TRI-PROOF FIXTURE FOR 2 LED TUBE 1.2M

2x36W | 1200mm | AC85-265V | 115x90x1260mm | 8/c

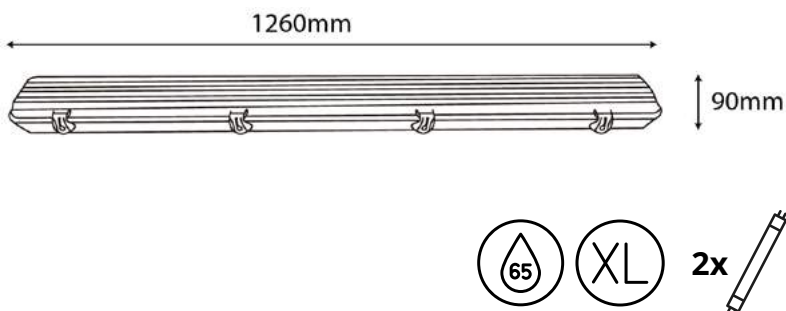

ATPF-2X36W

5999097916422

TRI-PROOF FIXTURE FOR 2 LED TUBE 1.5M

2x58W | 1500mm | AC85-265V | 115x90x1560mm | 8/c

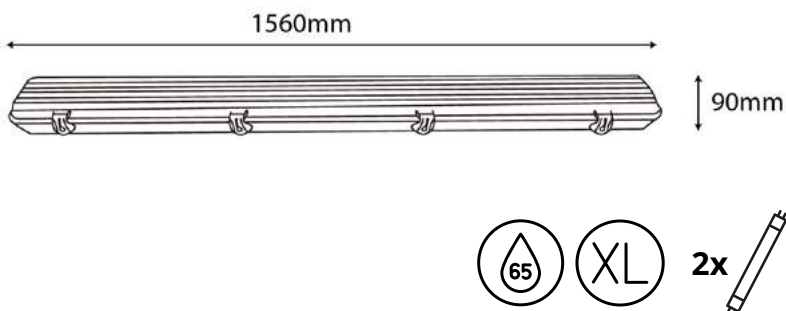

ATPF-2X58W

5999097916460

LED INTEGRATED TRI-PROOF FIXTURE 0.6M

E 20W | 1 900lm | AC180-265V | 105x600x600mm | 120° | 25 000h | 8/c

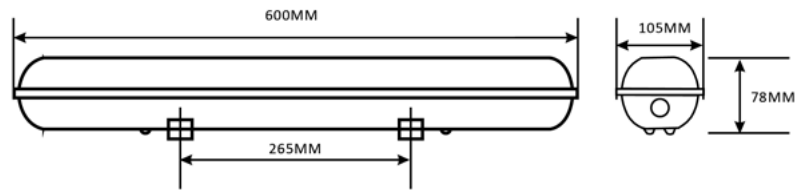

100lm/W

ATPF-LED-20W

5999097916484

LED INTEGRATED TRI-PROOF FIXTURE 1.2M

D 40W | 5 400lm | 185-265V | 78x1200x1200mm | 120° | 25 000h | 8/c

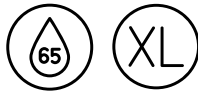
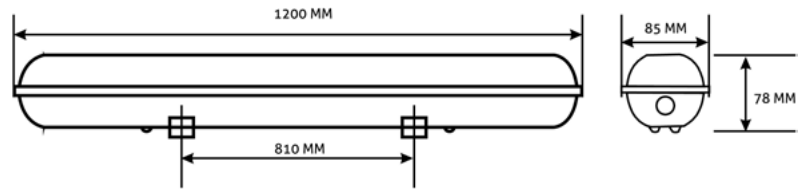

135lm/W

ATPFHL-LED-40W

5999097948843

LED INTEGRATED TRI-PROOF FIXTURE 1.5M

D 60W | 8 100lm | 185-265V | 78x1500x1500mm | 120° | 25 000h | 6/c

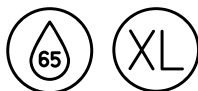
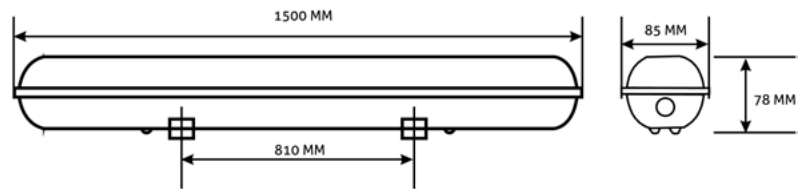

135lm/W

ATPFHL-LED-60W

5999097948867



LED NANO LIGHT LINKABLE 600MM

18W | 1 800lm | 220-240V | 41x680x680mm | 150° | 25 000h | 25/c 

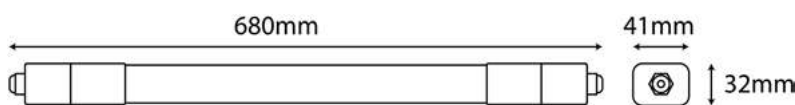

100lm/W



ALNLNW-18W

5999097923147

LED NANO LIGHT LINKABLE 1200MM

24W | 2 400lm | 220-240V | 41x1225x1225mm | 150° | 25 000h | 25/c 

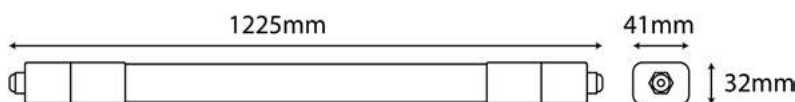

100lm/W



ALNLNW-24W

5999097923123

LED NANO LIGHT LINKABLE 1500MM

36W | 3 600lm | 220-240V | 41x1525x1525mm | 150° | 25 000h | 25/c 

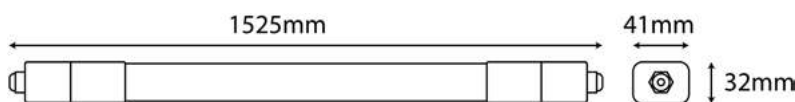

100lm/W



ALNLNW-36W

5999097923109