

# LEGENDA

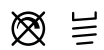

## NÁZEV PRODUKTU



PIKTOGRAMY

SPECIFIKACE

NÁČRT

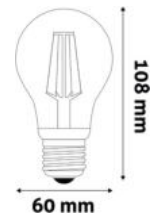

DALŠÍ  
INFORMACE

BARVA SVĚTLA  
(CHROMATIČNOST)

KÓD VÝROBKU EAN LUMEN DETAILY VÝROBKU

ENERGETICKÁ TŘÍDA



## TYPY PATIC



## VLASTNOSTI VÝROBKU



Výrobek s potlačením oslnění



Provozní doba



Velikost řezu v mm



Typ čipu



Vestavný LED zdroj



Počet konektorů



Z hlediska logistiky, výrobek je ve velikosti XL



výrobek s pohybovým senzorem



RGB



RGB+white



Dálkově ovladatelný



Nastavitelná teplota barva světla (chromatičnost)



Patice GU10



Patice E27



Režimy osvětlení



Okamžitý úplný jas



Stupeň krytí IP výrobku



Stmívatelné



Nestmívatelné



Zobrazení teploty



Funkce alarmu



Funkce kalendáře



Barva výrobku



Funguje s LED zářivkou



Funguje se šroubovacím světelným zdrojem



Funguje se světelným zdrojem GU10



Směr světla



Lze ovládat chytrým zařízením



Výrobek s rychlospojku IP68



Dotykově nastavitelné RGB okolní světlo



Životnost: výrobek je dostupný v omezeném množství a bude nahrazen jiným výrobkem



### **BATTEN LIGHTS**

Cabinet lighting luminaires are suitable for illuminating the work area. They can be used in kitchens, workshops or even indoors thanks to their clean appearance.

## BATTEN LIGHTS

---



**CABINET LIGHT + SENSOR**  
PAGE - 318.



**CABINET LIGHT + SENSOR**  
PAGE - 318.



**RECHARGEABLE CABINET LAMP PIR  
SENSOR**  
PAGE - 319.



**RECHARGEABLE CABINET LAMP PIR  
SENSOR**  
PAGE - 319.



**CABINET LIGHT + SENSOR**  
PAGE - 319.



**BATTEN LIGHTS**  
PAGE - 320.

**LED STRIP CABINET LIGHT + SENSOR**

**A F** 9W | 600mm | 220-240V | 120° | 25 000h | 30/c

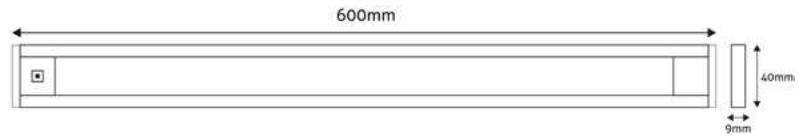

ABLSCAB-60NW-BL1

900lm

5999562288788

**LED STRIP CABINET LIGHT + SENSOR**

**A F** 5W | 500mm | 220-240V | 120° | 25 000h | 20/c

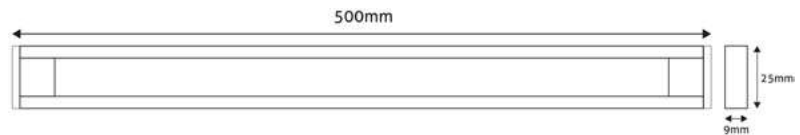

ABLSCAB-50NW-BL2

500lm

5999562288443

**LED STRIP CABINET LIGHT + SENSOR**

**A F** 9W | 600mm | 220-240V | 120° | 25 000h | 20/c

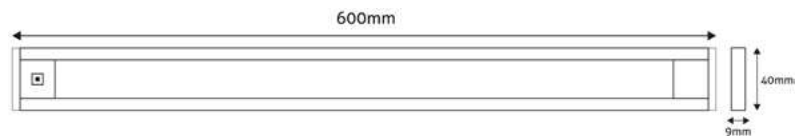

ABLSCAB-60NW-BL2

900lm

5999562288429



**LED CABINET LIGHT WITH BUILT-IN BATTERY PIR**

2.5W | 310mm | | 360° | 25 000h | 60/c

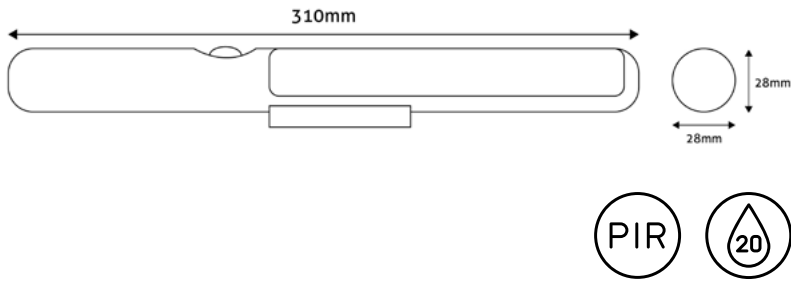

ABLSBCAB-30WWR	200lm	5999097943008
----------------	-------	---------------

**LED CABINET LIGHT WITH BUILT-IN BATTERY PIR**

2.5W | 300mm | V | 360° | 25 000h | 40/c

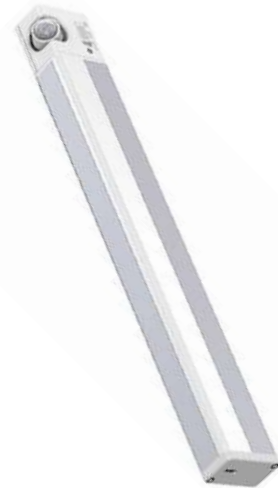
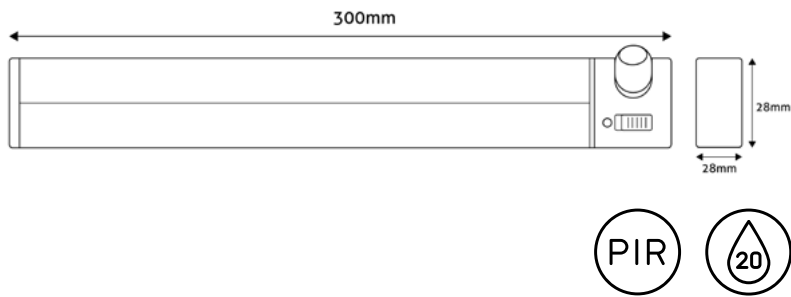

ABLSBCAB-30WWS	200lm	5999097943022
----------------	-------	---------------

**LED CABINET LIGHT WITH HANDWAVE SENSOR**

9W | 600mm | 220-240V | 360° | 25 000h | 40/c

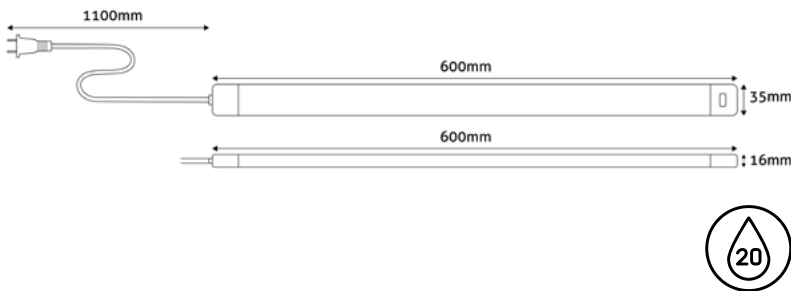

ABLSCAB-60WW-HS	500lm	5999097952444
ABLSCAB-60NW-HS	500lm	5999097943046



**LED BATTEN LIGHT**

16W | 600mm | 220-240V | 120° | 20 000h | 50/c

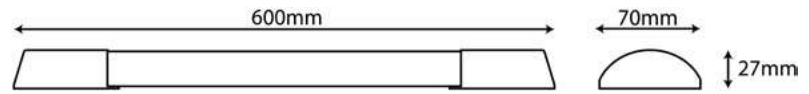

ALBLWW-16W	1 472lm	5999097919881
ALBLNW-16W	1 600lm	5999097919805
ALBLCW-16W	1 600lm	5999097919966



**LED BATTEN LIGHT**

30W | 1 200mm | 220-240V | 120° | 20 000h | 40/c

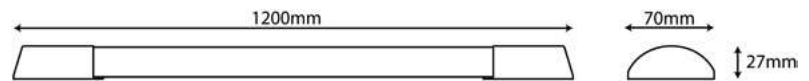

ALBLWW-30W	2 760lm	5999097919928
ALBLNW-30W	3 000lm	5999097919843
ALBLCW-30W	3 000lm	5999097920009



**LED CABINET LIGHT EXCL.**

0.7W | 260mm | 120° | 60/c

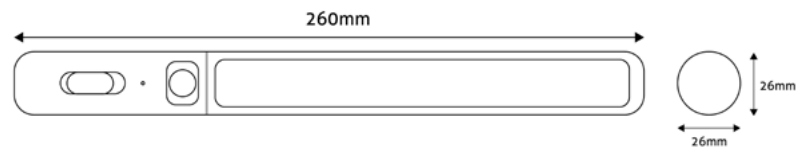

ABLBCAB3AA-26WWR	87lm	5999097949864
------------------	------	---------------



BATTEN LIGHTS



## LED TUBES

LED fluorescent tubes offer solution to replace conventional fluorescent tubes. Their brightness surpasses even of the neon tubes, their consumption is measurably lower. Integrated LED fluorescent tubes are flicker-free and they illuminate at their full brightness once switched on.



# LED TUBES

---



**INTEGRATED LED**  
PAGE - 324.



**CABLE**  
PAGE - 325.



**LED GLASS TUBE**  
PAGE - 326.



**LED LINEAR**  
PAGE - 330.

INTEGRATED LED



**LED T5 INTEGRATED TUBE WITH AC PLUG**

6W | 600lm | 300mm | 120° | 220-240V | 25 000h | 25/c



AB300T5-6W-WW-CB	5999097943305
AB300T5-6W-NW-CB	5999097943282



**LED T5 INTEGRATED TUBE**

9W | 890lm | 600mm | 120° | 220-240V | 25 000h | 25/c

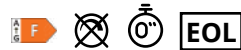

AB600T5-9W-WW	5999097909301
---------------	---------------



**LED T5 INTEGRATED TUBE WITH AC PLUG**

9W | 850lm | 600mm | 120° | 220-240V | 25 000h | 25/c



AB600T5-9W-WW-CB	5999097934648
AB600T5-9W-NW-CB	5999097934624



**LED T5 INTEGRATED TUBE WITH AC PLUG**

15W | 1 500lm | 900mm | 120° | 220-240V | 25 000h | 25/c



AB900T5-15W-WW-CB	5999097934501
AB900T5-15W-NW-CB	5999097934488



**LED T5 INTEGRATED TUBE WITH AC PLUG**

19W | 2 000lm | 1 200mm | 120° | 220-240V | 25 000h | 25/c



AB1200T5-19W-WW-CB	5999097934426
AB1200T5-19W-NW-CB	5999097934600



**CABLE**

---

**LED T5 INTEGRATED TUBE CONNECTOR CABLE**

150mm



---

ABT5-CON

5999097909967

---

**LED T5 INTEGRATED TUBE AC PLUG**

220-240V | 6A | 1m |



---

ABT5-ACPLUG

5999562280089

---

**ECO LED TUBE  
100LM/W**

**LED GLASS TUBE**

9W | 900lm | 600mm | 240° | 175-265V | 25 000h | 25/c

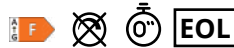

**100lm/W**

AE600T8-9W-NW	5999097945842
AE600T8-9W-CW	5999097947884

**LED GLASS TUBE**

9W | 900lm | 600mm | 240° | 175-265V | 25 000h | 25/c



**100lm/W**

AEI600T8-9W-NW	5999097947983
AEI600T8-9W-CW	5999097948003

**LED GLASS TUBE**

18W | 1 800lm | 1 200mm | 240° | 175-265V | 25 000h | 25/c



**100lm/W**

AE1200T8-18W-NW	5999097945866
AE1200T8-18W-CW	5999097947921

**LED GLASS TUBE**

18W | 1 800lm | 1 200mm | 240° | 175-265V | 25 000h | 25/c



**100lm/W**

AEI1200T8-18W-NW	5999097947945
AEI1200T8-18W-CW	5999097948041

**LED GLASS TUBE**

18W | 2 160lm | 1 200mm | 240° | 180-265V | 25 000h | 25/c



**100lm/W**

AB1200T8-18W-NW-GL-IL-1	5999097950341
-------------------------	---------------



LED GLASS TUBE

24W | 2 400lm | 1 500mm | 240° | 175-265V | 25 000h | 25/c



100lm/W



AE1500T8-24W-NW	5999097945880
AE1500T8-24W-CW	5999097947907

LED GLASS TUBE

24W | 2 400lm | 1 500mm | 240° | 175-265V | 25 000h | 25/c

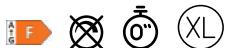

100lm/W



AEI1500T8-24W-NW	5999097947969
AEI1500T8-24W-CW	5999097948027

LED GLASS TUBE

24W | 2 350lm | 1 500mm | 240° | 220-240V | 20 000h | 25/c



100lm/W



AB1500T8-24W-WW-GL	5999562289426
--------------------	---------------

PROFESSIONAL LED TUBE  
120LM/W

LED GLASS TUBE

9W | 1 080lm | 600mm | 240° | 175-265V | 25 000h | 25/c



120lm/W



AEI600T8-9W-NW-IL	5999097948225
-------------------	---------------

LED GLASS TUBE

9W | 1 030lm | 600mm | 240° | 180-265V | 25 000h | 25/c



120lm/W



AB600T8-9W-WW-GL-IL	5999097925424
AB600T8-9W-NW-GL-IL	5999097925448
AB600T8-9W-CW-GL-IL	5999097925462

**LED GLASS TUBE PAPERTUBE**

9W | 1 080lm | 600mm | 240° | 180-265V | 25 000h | 25/c



**120lm/W**

AB600T8-9W-NW-GL-IL-1

5999097925721

**LED GLASS TUBE**

18W | 2 160lm | 1 200mm | 240° | 175-265V | 2 500h | 25/c



**120lm/W**

AEI1200T8-18W-NW-IL

5999097948188

**LED GLASS TUBE**

18W | 2 110lm | 1 200mm | 240° | 180-265V | 25 000h | 25/c



**120lm/W**

AB1200T8-18W-WW-GL-IL

5999097925486

AB1200T8-18W-NW-GL-IL

5999097925509

AB1200T8-18W-CW-GL-IL

5999097925523

22W | 2 640lm | 1 500mm | 240° | 180-265V | 25 000h | 25/c



**120lm/W**

AB1500T8-22W-NW-GL-IL-1

5999097945163

**LED GLASS TUBE**

22W | 2 640lm | 1 500mm | 240° | 180-265V | 25 000h | 25/c



**120lm/W**

AB1500T8-22W-NW-GL-IL

5999097945125

AB1500T8-22W-CW-GL-IL

5999097943268

**LED GLASS TUBE**

24W | 2 880lm | 1 500mm | 240° | 175-265V | 25 000h | 25/c



**120lm/W**

AEI1500T8-24W-NW-IL

5999097948201



## INDUSTRIAL LED TUBE 150LM/W

### LED GLASS TUBE HIGH LUMEN

9W | 1 350lm | 600mm | 240° | 180-265V | 25 000h | 25/c

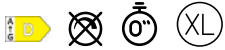

**150lm/W**



AB600T8-9W-NW-GL-HL

5999097923581

### LED GLASS TUBE HIGH LUMEN

18W | 2 700lm | 1 200mm | 240° | 180-265V | 25 000h | 25/c



**150lm/W**



AB1200T8-18W-NW-GL-HL

5999097923642

### LED GLASS TUBE

22W | 3 300lm | 1 500mm | 240° | 180-265V | 48 000h | 25/c



**150lm/W**



AB1500T8-22W-NW-GL-HL

5999097945149

## ACCESSORIES

### LED TUBE STARTER - T8 G13

25/x



ALT8S

5999097913742

LED LINEAR

**LED LINEAR S14D**



5W | 450lm | 300mm | 120° | 220-240V | 25 000h | 50/c



ABS14DNW-5W	5999562284650
-------------	---------------

**LED LINEAR S14S**



5W | 400lm | 300mm | 120° | 220-240V | 25 000h | 50/c



ABS14SNW-5W	5999562284636
-------------	---------------

**LED LINEAR S14D**



8W | 630lm | 500mm | 120° | 220-240V | 25 000h | 50/c



ABS14DWW-8W	5999097920443
ABS14DNW-8W	5999562289266

**LED LINEAR S14S**



8W | 700lm | 500mm | 120° | 220-240V | 25 000h | 50/c

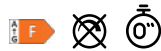

ABS14SNW-8W	5999562289280
-------------	---------------

**LED LINEAR S14S**



8W | 630lm | 500mm | 120° | 220-240V | 25 000h | 50/c

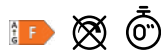

ABS14SWW-8W	5999097920467
-------------	---------------





**GLASS TUBE**  
**G13**



SMD  
LED

CRI > 80





### TRI-PROOF FIXTURES

Due to their IP65 protection, these luminaires are fully protected from dust and vapour, thus, they have a high level of protection against entry of vapour, dust and other solids. They are recommended for the illumination of industrial halls, storage rooms, corridors, workshop rooms or cellars.

## TRI-PROOF FIXTURES

---



**TRI-PROOF FIXTURES**  
PAGE - 334.



**LED INTEGRATED TRI-PROOF  
FIXTURE**  
PAGE - 336.

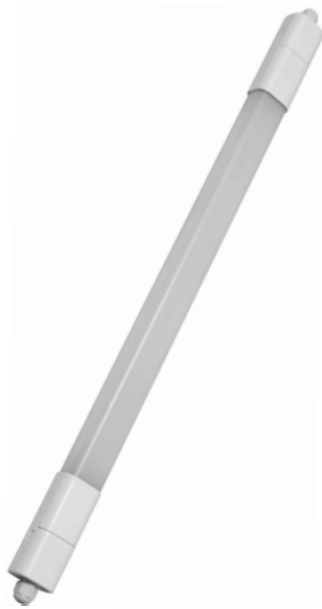

**LED NANO LIGHT LINKABLE**  
PAGE - 338.



**TRI-PROOF FIXTURE**

1x18W | 600mm | AC85-265V | 90x600x656mm | 12/c

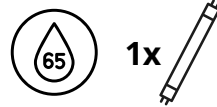
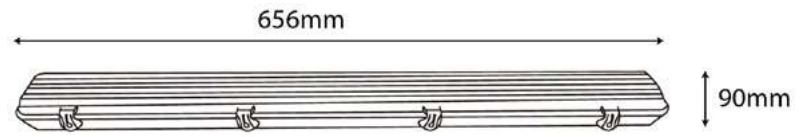

ATPF-1X18W

5999097916361



**TRI-PROOF FIXTURE**

1x36W | 1200mm | AC85-265V | 80x90x1260mm | 12/c

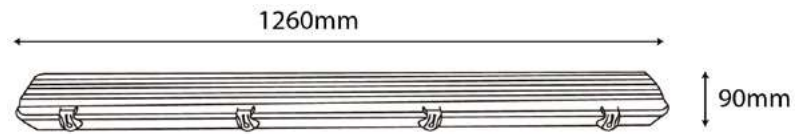

ATPF-1X36W

5999097916408



**TRI-PROOF FIXTURE**

1x58W | 1500mm | AC85-265V | 80x90x1560mm | 8/c

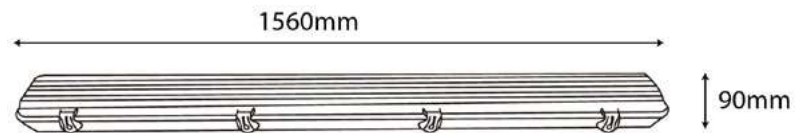

ATPF-1X58W

5999097916446



**TRI-PROOF FIXTURE**

2x18W | 600mm | AC85-265V | 115x90x656mm | 8/c

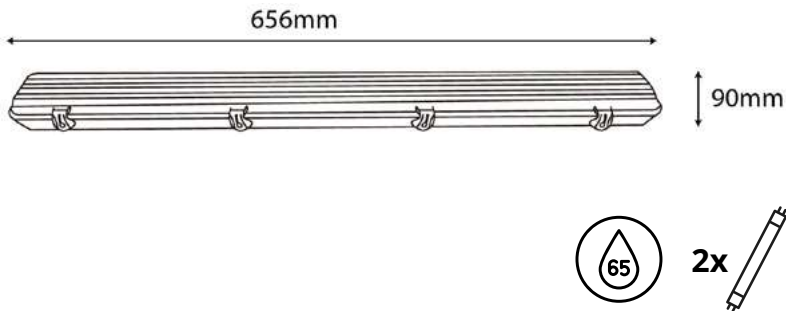

ATPF-2X18W

5999097916385



**TRI-PROOF FIXTURE**

2x36W | 1200mm | AC85-265V | 115x90x1260mm | 8/c

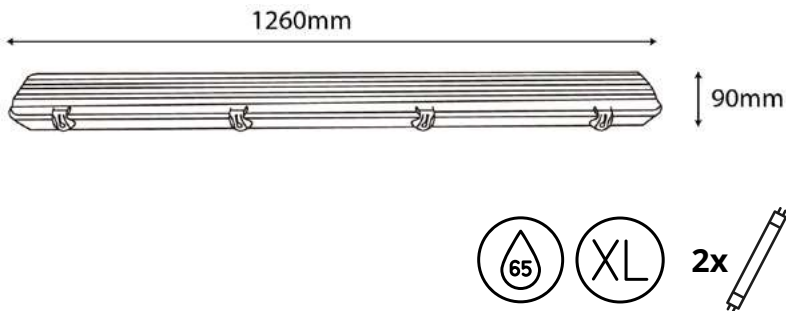

ATPF-2X36W

5999097916422



**TRI-PROOF FIXTURE**

2x58W | 1500mm | AC85-265V | 115x90x1560mm | 8/c

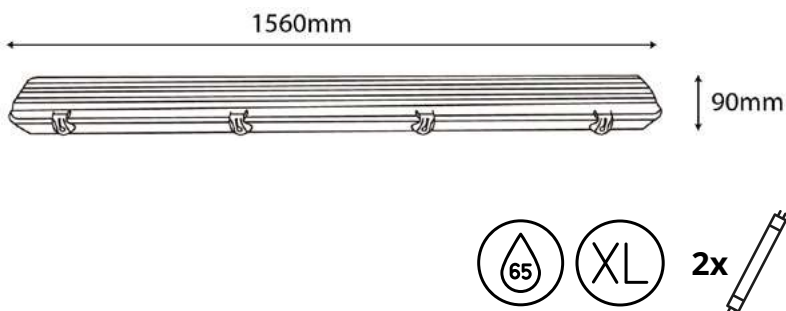

ATPF-2X58W

5999097916460



**LED INTEGRATED TRI-PROOF FIXTURE**



**E** 20W | 1 900lm | AC180-265V | 105x78x600mm | 120° | 25 000h | 8/c

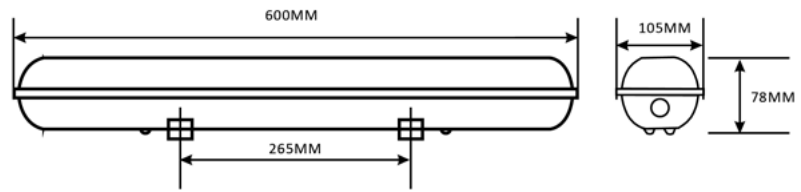

ATPF-LED-20W

5999097916484

**LED INTEGRATED TRI-PROOF FIXTURE**



**E** 40W | 3 800lm | AC180-265V | 105x78x1200mm | 120° | 25 000h | 8/c

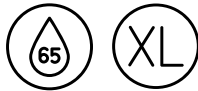
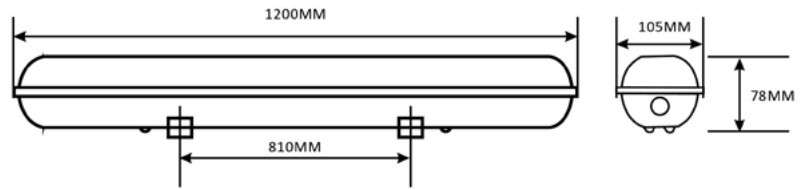

ATPF-LED-40W

5999097916507

**LED INTEGRATED TRI-PROOF FIXTURE**



**E** 60W | 5 700lm | AC180-265V | 105x78x1500mm | 120° | 25 000h | 6/c

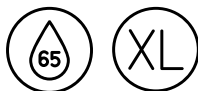
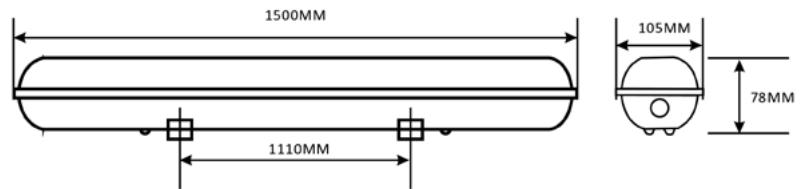

ATPF-LED-60W

5999097916521



LED INTEGRATED TRI-PROOF FIXTURE

40W | 5 400lm | 185-265V | 78x1200mm | 120° | 25 000h | 8/c

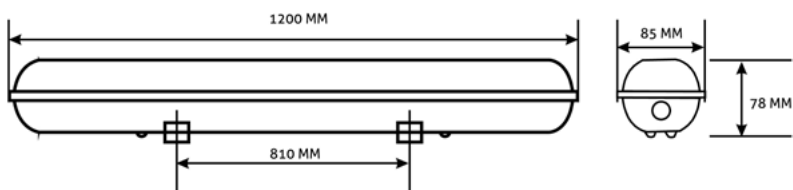

**135lm/W**

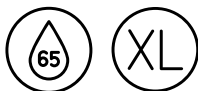

ATPFHL-LED-40W

5999097948843

LED INTEGRATED TRI-PROOF FIXTURE

60W | 8 100lm | 185-265V | 78x1500mm | 120° | 25 000h | 6/c

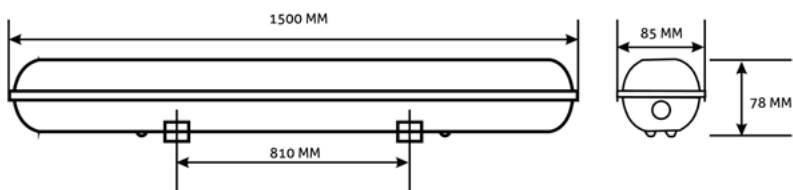

**135lm/W**

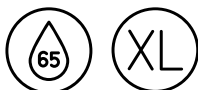

ATPFHL-LED-60W

5999097948867

**LED NANO LIGHT LINKABLE**

 18W | 1 800lm | 220-240V | 41x32x680mm | 150° | 25 000h | 25/c

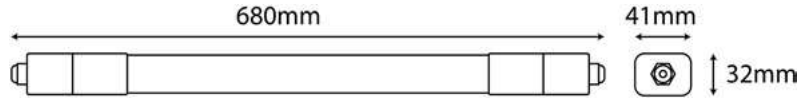

ALNLNW-18W

5999097923147

**LED NANO LIGHT LINKABLE**

 24W | 2 400lm | 220-240V | 41x32x1225mm | 150° | 25 000h | 25/c

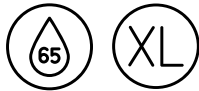
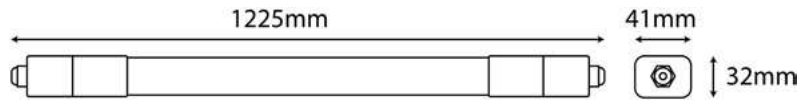

ALNLNW-24W

5999097923123

**LED NANO LIGHT LINKABLE**

 36W | 3 600lm | 220-240V | 41x32x1525mm | 150° | 25 000h | 25/c

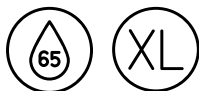
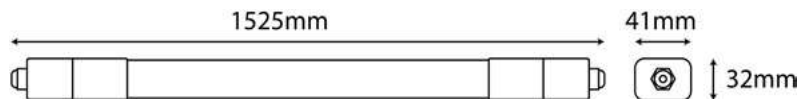

ALNLNW-36W

5999097923109





TRI-PROOF FIXTURES

